

# Technology to understand and change the world

Can digital experiences based on real world exploration give children positive feelings of astonishment, awe and wonder?



*...technology transforming learning*



# Educational technology trends

Themes from my recent work:

- Pedagogical approaches:
  - Computational thinking
  - Design thinking
- Technologies across the curriculum:
  - Outdoor learning
  - STEAM



*...strands of current work*

# Primary Computing

- Children will 'use computational thinking and creativity to understand and change the world' (National Curriculum)
- Begin by building metacognition using the key concepts and approaches so that thinking strategies are explicit and transferable
- Combine unplugged, plugged and real world applications



[www.barefootcas.org.uk](http://www.barefootcas.org.uk)  
© Crown copyright 2014 (DGL)

Barefoot would like to acknowledge the work of Julia Briggs and the eLJIM team at Somerset County Council for their contribution to this poster.

*...where to start with primary computing?*

# Computational thinking

Digital makers:  
 creators,  
 collaborators,  
 digitally critical,  
 responsible and  
 active learners  
 who use  
 computational  
 thinking across  
 the curriculum

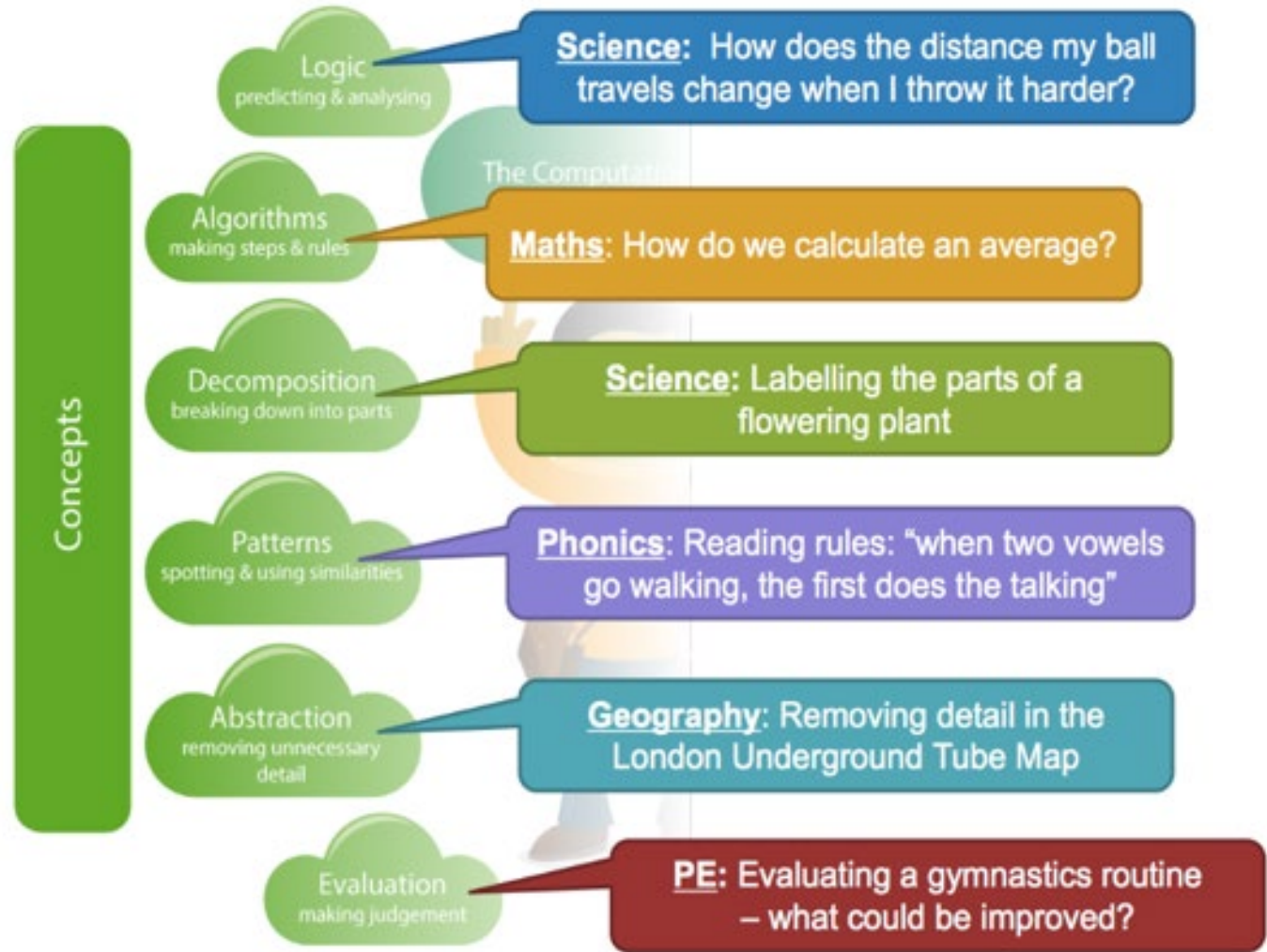

*...demystifying and reinforcing*



# Build repertoire rather than recipes

**UPTIME**  
**U**se  
**P**lay  
**T**inker  
**I**mprove  
**M**ake  
**E**valuate



Coding recipes are not purposeful and challenging. Rather than easy wins, we should do projects that build a coding repertoire not recipes.

Moving from **computational thinking** to **computational participation** (Kafai and Burke 2014). Coding as a social activity.

<https://challengingcomputing.wordpress.com/uptime/>

Chris Shelton University of Chichester

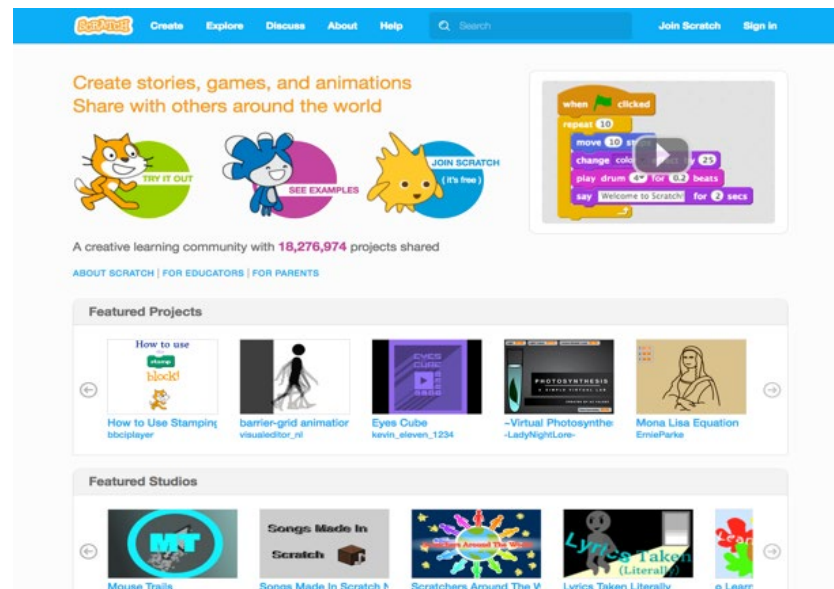

*...UPTIME scaffolding learning-driven planning*



# Computing unplugged

## Teaching computing? Try switching off your screens

From robot hamsters to beatboxing, there are plenty of activities to help students develop thinking skills associated with programming. No computers needed



**i** Moving away from computers can often help students understand ideas behind programming without being distracted by the technology. Photograph: Alamy

### Human beatbox

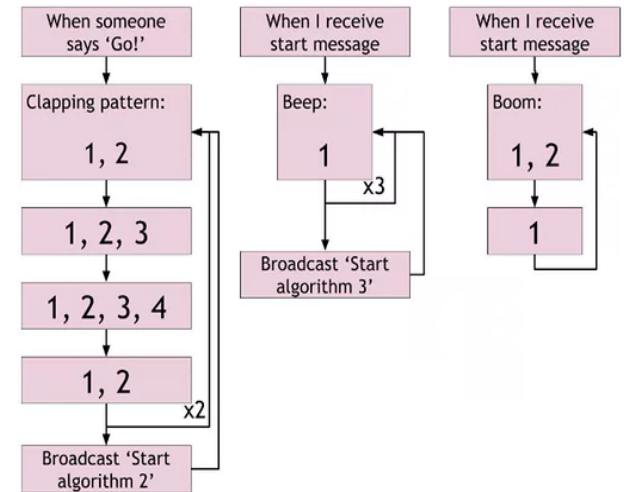

### Robot hamster playground

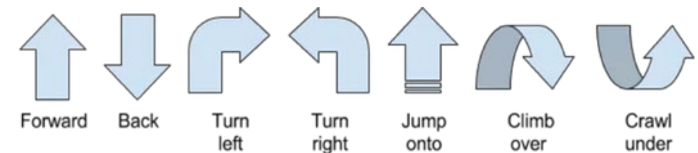



# Everyday algorithms

## Chair stacking

Repeat 32 times:

**If previous chair is stacked:**

**Then** stand behind chair

Pick up chair

Walk to the aisle

Walk to front of the first set of tables

**If there are no chairs there:**

**Then** place chair nearest the door

**Else**

**If there are less than 5 chairs in the stack:**

Add chair to stack

**Else**

Make new stack next to previous

**Else**

Wait

*...computational thinking in everyday tasks*

# Makey Makey Playdate



*...time for tinkering and experimenting*





# Rescue Robots



*...real world applications*

# Erasmus+ and eTwinning

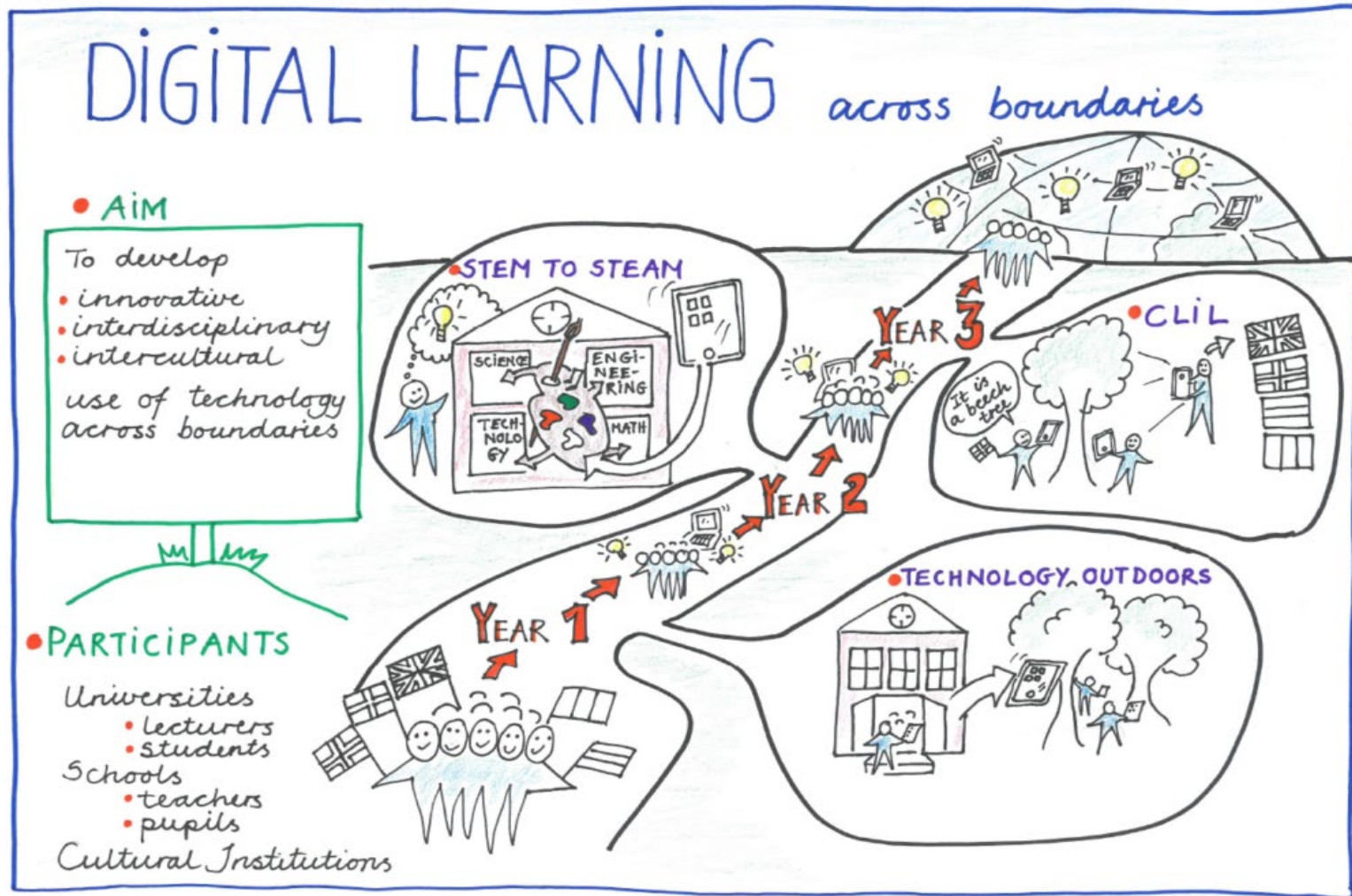

<http://dlaberasmus.eu/>

<https://plus.google.com/communities/117458443566280105364>

...crossing boundaries of space, subjects and languages



# Ephemeral art



## Science links:

Freezing and melting

Decay

Evaporation

Condensation

Light



*...transient art in the environment*

# Art swaps



<http://www.pictaculous.com>  
<http://www.sketchbookcircle.com>  
<http://virtualpaintout.blogspot.co.uk>

*...technology as a lens for looking at the world*



# Virtual sculptures



*...building bridges with others through art*

# Creating trails

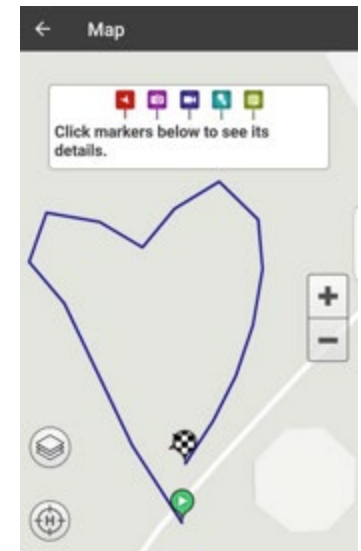
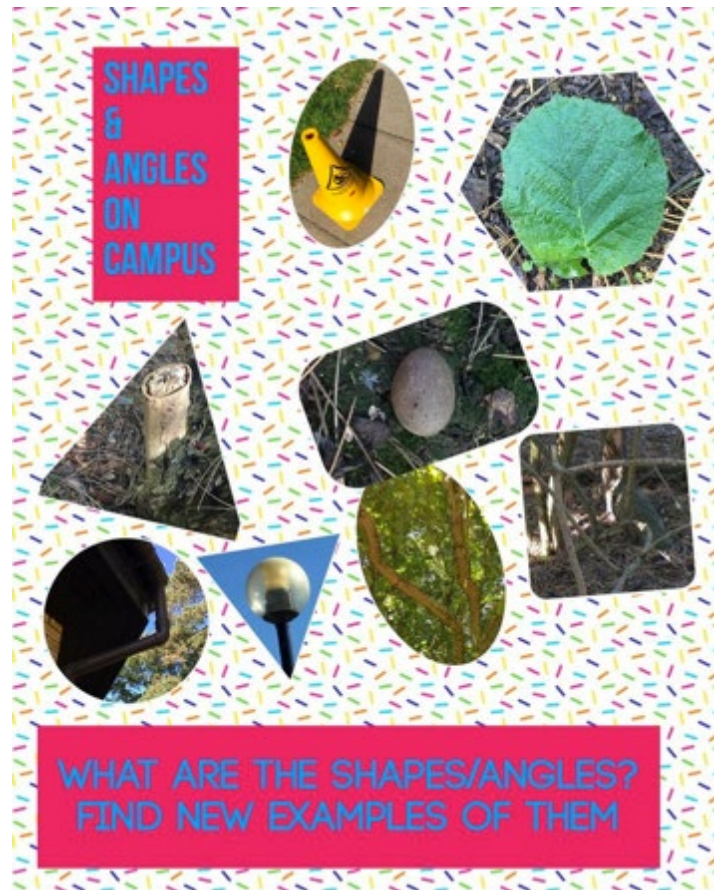

...combining digital and physical exploration

# I am the pencil

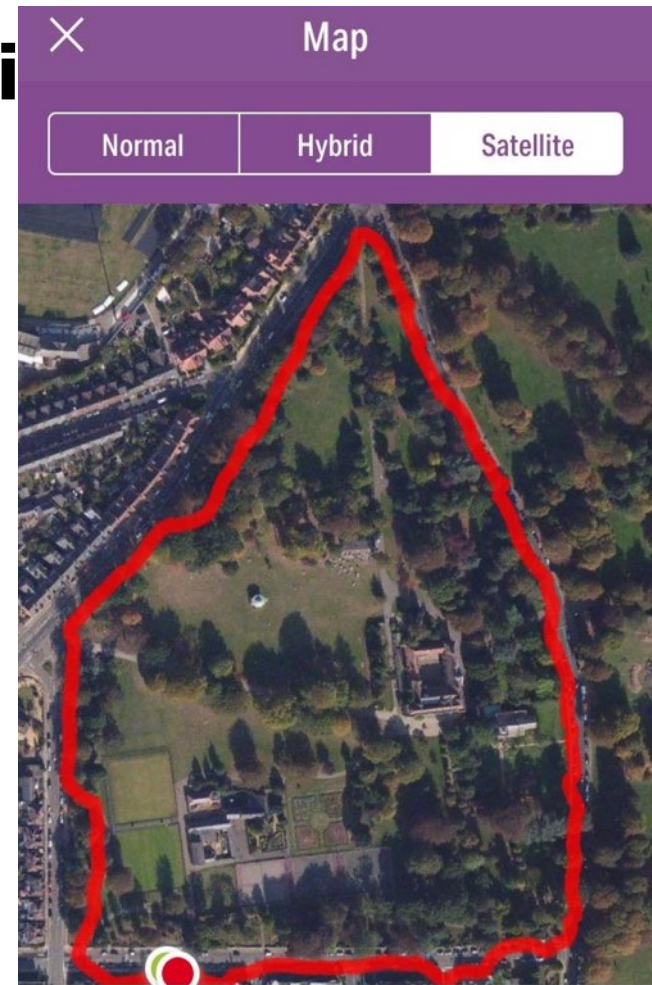
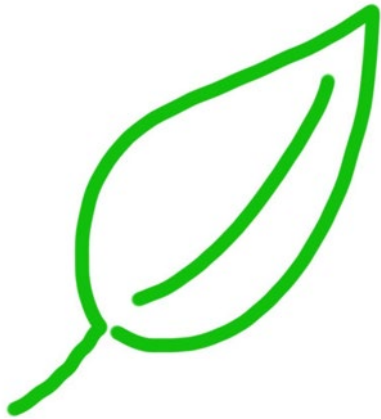

...Ramblr, MapMyWalk, QR codes, PicCollage, Leafsnap

# Walking a line



Walking a line, Wyboston Lakes,  
winter  
A frozen puddle  
A spiral in a frozen puddle  
Bicycle tracks in mud  
Cold pale blue sky  
Frost on branches like crystals  
Ice on every blade of grass  
Molehills pepper the field  
Ice melting  
A pigeon feather drops from the  
sky  
Irregular paving strewn around  
Leaves outlined by frost

Look up  
Sleeping rain  
Red kite  
Gliding  
Swooping  
Wing full of wishes  
Beak full of menace  
Hide  
Coming for you  
Stay alert  
Survive



Walking a line in the park  
Stopping after 15 steps  
Looking down 15 times

Green grass  
White daisy  
**Lost leaf**  
Broken twigs  
Flight feather  
**Plastic litter**  
New leaves  
Young dandelion  
Gnarled roots  
Fluffy feather  
Small stone  
Pink petals  
Pink petals  
Pink petals



Who's in this photo?

<http://www.richardlong.org>

...photo-journeys inspiring writing





# Wild writing

What's in the drawers?



The secret life of the outdoors



...mobiles capturing outdoor learning



# Wild writing



My Books Pages Undo Page 2 (of 3) + ⓘ 📄



The tree fuels the air  
The tree fills our body  
and mind  
with the soul of the  
earth  
the soil where we live  
from

< >

Swirling pine



*...manipulating images and viewpoints*



# Bringing the outside in

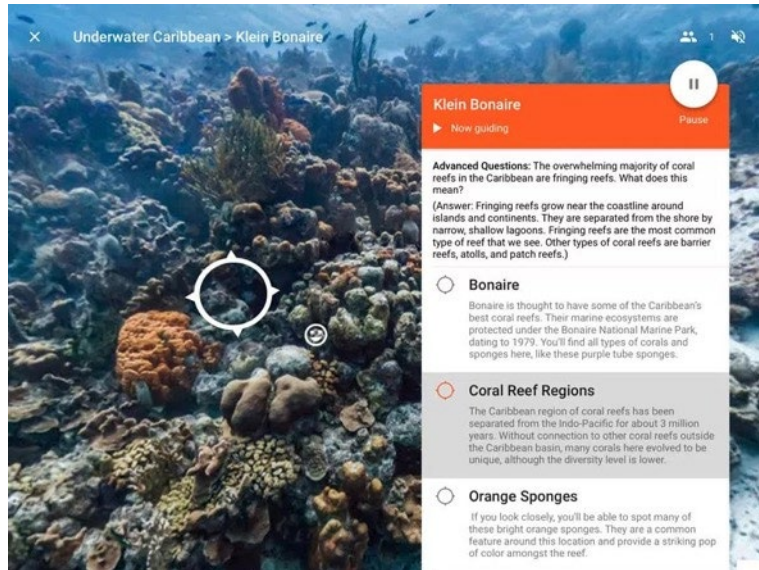
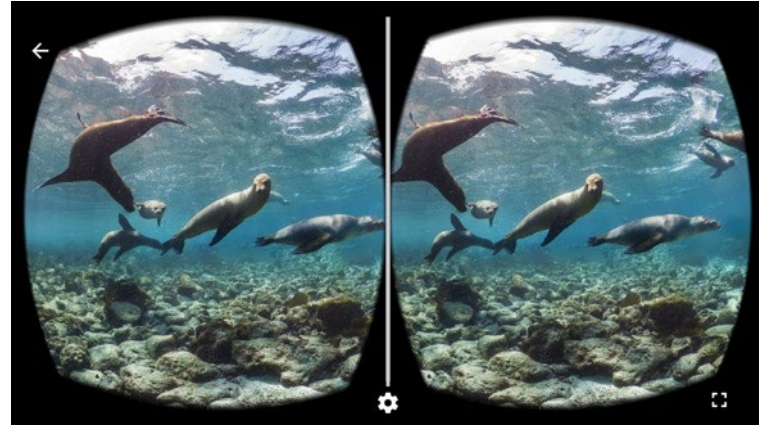

...AR and VR merging real and virtual worlds



# Manipulating media



*...from green screening to VR 360 as a creative medium*



# Technology supporting SEND



Apps:  
Rollworld  
Fragment  
Be Funky

# Digital meets physical

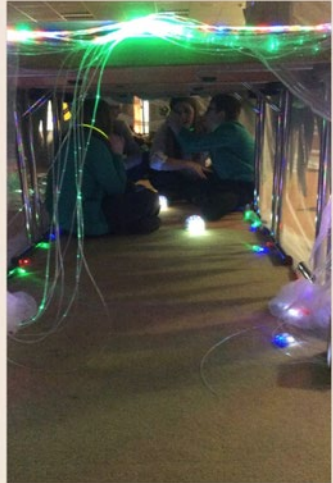

*...moving between digital and physical spaces*

# Exploring STEAM



Digital Learning across Boundaries through  
adding the Arts to STEM

***A DLaB STEAM activity uses digital technologies to cross boundaries by adding the arts into STEM and providing opportunities to build intercultural connections.***



# STEAM weeks







# STEAM with Design Thinking



Think about a three part plan:

1. A trigger
2. A vision and plan
3. A creative solution

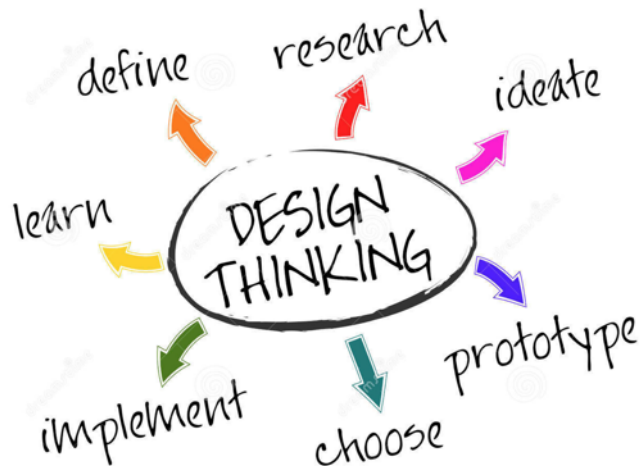
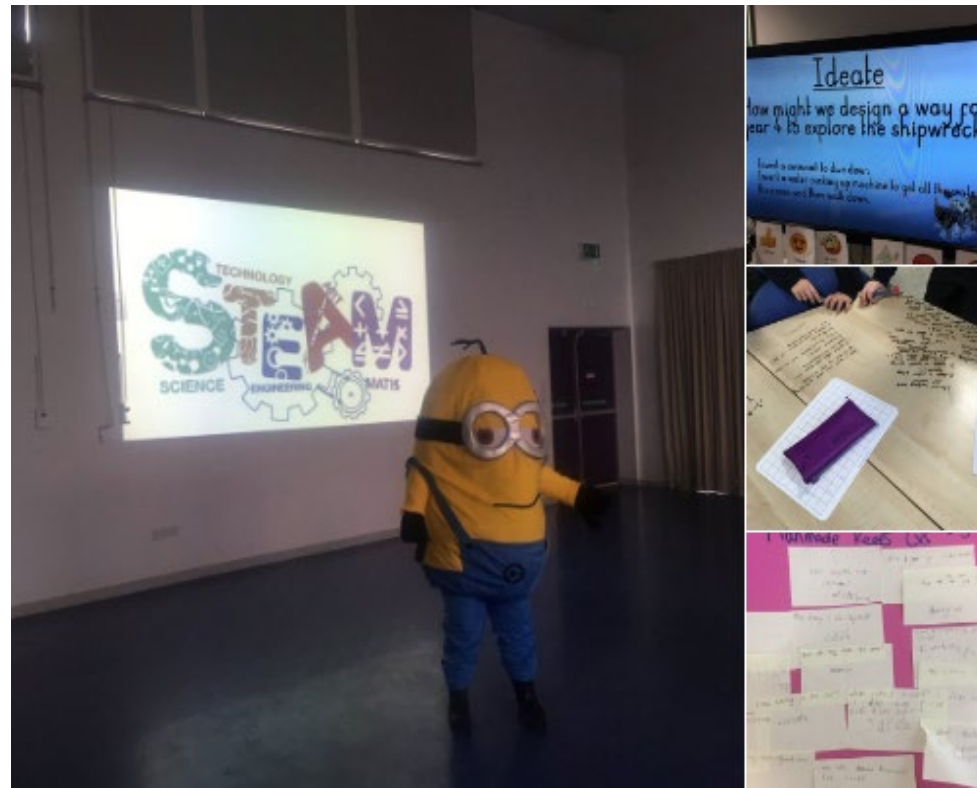

*...digital makers discovering solutions*

# Seeing, hearing and experiencing STEAM

Overlapping arts:

1. Visual art, drawing, painting, printmaking, collage, photography, textiles, sculpture, installation, digital arts, graffiti
2. Music and sounds, sound art, spoken word
3. Drama, performance, dance, spoken word
4. Literature, poetry, written text, sci fi, comics



The Solar Sea Sweeper

*A solar-powered water vehicle that collects and compacts waste*

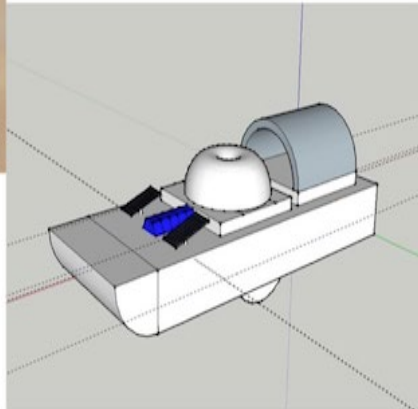

The Sea Dog

*A robotic dog that swims and collects rubbish from the ocean*



*...tinkering, making and inventing*

# Makerspaces and breakerspaces



# Wearables and the Internet of Things

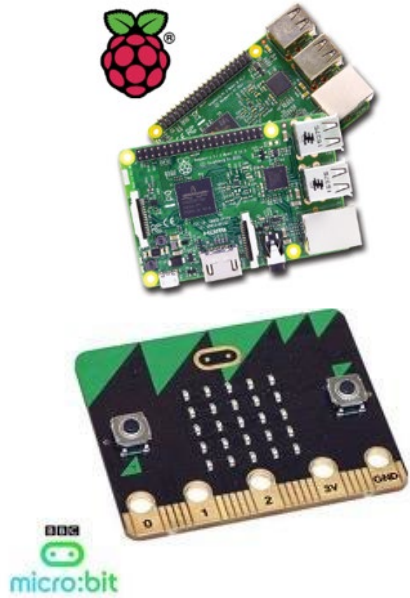

And we have a t shirt that lights up when you jump! @neilnjae @SwayGrantham @JeanEd70



Wearable tech Pointe Shoes [arra]stre



*...inspired by computing and performance*



# Technology transforming learning



*...bridging formal and informal learning and multiplying learning opportunities*

# Helen Caldwell

**Apple Distinguished Educator**  
**Raspberry Pi Certified Educator**

## Books

- Caldwell H. & Cullingford-Agnew, S. (2017). *Technology for SEND in Primary Schools: A good practice guide*. London: Sage.
- Caldwell, H. & Smith, N (2016). *Computing Unplugged: Exploring primary computing through practical activities away from the computer*. London: Sage.
- Wise, N. & Caldwell, H. (2016). *Help with Homework: Coding Essentials*. Chichester: Igloo Books.
- Caldwell, H. & Bird, J. (2015). *Teaching with Tablets*. London: Sage.
- Caldwell, H., Heaton, R., Whewell, E. & Grantham, S. (2015) *Switched on iPads Science*. London: Rising Stars.
- Bird, J., Caldwell, H. & Mayne, P. (2014). *Lessons in Teaching Computing in Primary Schools*. London: Sage.

## MOOCs

- Let's Teach Computing 2015
- Teaching with Tablets 2016
- Technology Outdoors 2017

## Current Project

- **Digital Learning Across Boundaries** International Erasmus project

## Contact

[helen.caldwell@northampton.ac.uk](mailto:helen.caldwell@northampton.ac.uk)  
[@helencaldwel](#)

## Links

**DLaB community**

<http://bit.ly/DLaBERasmus>

**DLaB website**

<http://dlaberasmus.eu/>